

FEATURES

- Full interchangeability with no calibration required in standard conditions
- Instantaneous desaturation after long periods in saturation phase
- I²C digital output
- Demonstrated reliability and long term stability
- Reliability not affected by repeated condensation

APPLICATIONS

- Home Appliance
- Medical
- Printers
- Humidifier

HTU(F)3800 SERIES

Digital Relative Humidity module with Temperature output

SPECIFICATIONS

- Compact plug and play module with no external component required
- Can operate under 5VDC or 3VDC
- Relative Humidity and Temperature Digital Output, I²C interface
- Full interchangeability. No calibration required
- Can operate under 5VDC or 3VDC
- Low power consumption
- Fast response time

Based on the new digital humidity module HTU21D, HTU3800 Series are dedicated humidity and temperature plug and play transducer designed for OEM applications where reliable and accurate measurements are needed. Direct interface with a micro-controller is made possible with the module humidity and temperature digital outputs. HTU3800 Series modules are designed for high volume and cost sensitive applications where power consumption is critical.

Every module is individually calibrated and tested, linearized signals in digital, I²C format. Furthermore, the resolution of HTU3800 Series digital humidity and temperature module can be changed by command (8/12bit up to 12/14bit for RH/T), low battery can be detected and a checksum improves communication reliability.

Optional PTFE filter/membrane (F) protects HTU3800 Series digital humidity modules with temperature output against dust, water immersion as well as against contamination by particles. PTFE filter/membrane preserves a high response time. Several connectors are proposed. 5VDC or 3VDC power supply products are available

HTU(F)3800 SERIES

Digital Relative Humidity module with Temperature output

NOMENCLATURE

HTU(F)3X3Yzzz

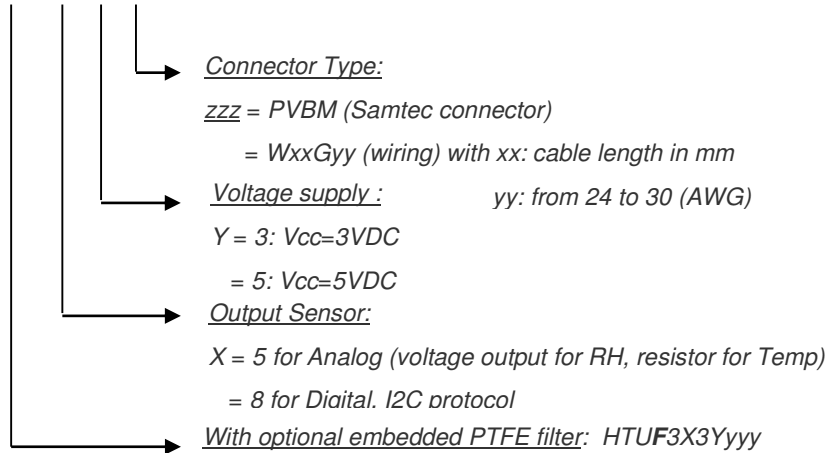

PERFORMANCE SPECS

MAXIMUM RATINGS

Ratings	Symbol	Value	Unit
Storage Temperature	T _{stg}	-40 to 125	°C
Supply Voltage (Peak)	HTU3833 products	V _{cc}	3.8V
	HTU3835 products	V _{cc}	16V
Humidity Operating Range	RH	0 to 100	%RH
Temperature Operating Range	T _a	-40 to +85	°C
VDD to GND	HTU3833 products		-0.3 to 3.6V
	HTU3835 products		-16 to 16V
Digital I/O pins (DATA/SCK) to VDD			-0.3 to VDD+0.3
Input current on any pin			-10 to +10

Peak conditions: less than 10% of the operating time

Exposure to absolute maximum rating conditions for extended periods may affect the module reliability.

OPERATING RANGE

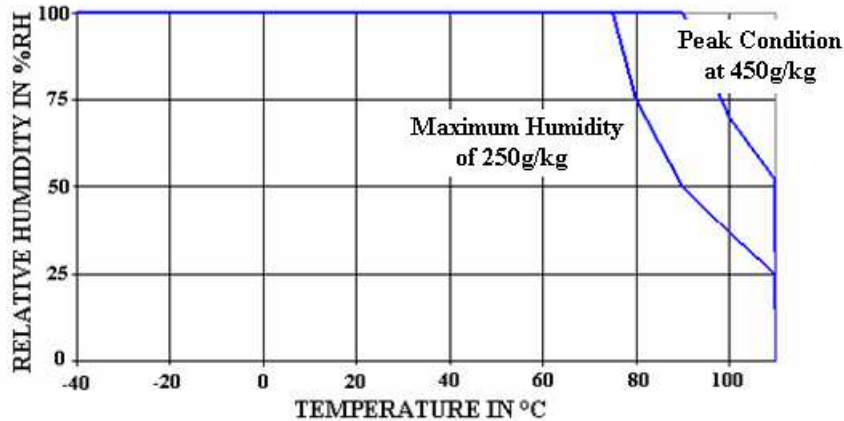

HTU(F)3800 SERIES

Digital Relative Humidity module with Temperature output

ELECTRICAL AND GENERAL ITEMS

• HTU3833 Products

(@T = 25°C, @Vdd=3V)

Characteristics	Symbol	Min	Typ	Max	Unit
Voltage Supply	VDD	1.5	3.0	3.6	V
Current consumption ⁽¹⁾	Sleep mode	idd	0.02	0.14	μA
	Measuring		300	450	500
Power Dissipation	Sleep mode		0.06	0.5	μW
	Average 8bit ⁽²⁾		2.7		μW
Communication	digital 2-wire interface, I ² C protocol				
Heater	VDD=3V	5.5mW/ΔT=+0.5-1.5°C			
Storage	-40°C/125°C				

⁽¹⁾ Conditions: V_{dd} = 3V, SCK= 400kHz at 25°C

⁽²⁾ Conditions: V_{dd} = 3V, SCK= 400kHz, Temp<60°C, duty cycle <10%

• HTU3835 Products

(@T = 25°C, @Vdd=5V)

Characteristics	Symbol	Min	Typ	Max	Unit
Voltage Supply	VDD	4.75	5.0	5.25	V
Current consumption ⁽¹⁾	Sleep mode	idd	0.5	1.5	μA
	Measuring		130	460	600
Power Dissipation	Sleep mode		2.5	7.9	μW
	Average 8bit ⁽²⁾		4.6		μW
Communication	digital 2-wire interface, I ² C protocol				
Heater	VDD=5V	5.5mW/ΔT=+0.5-1.5°C			
Storage	-40°C/125°C				

⁽¹⁾ Conditions: V_{dd} = 5V, SCK= 400kHz at 25°C

⁽²⁾ Conditions: V_{dd} = 5V, SCK= 400kHz, Temp<60°C, duty cycle <10%

HTU(F)3800 SERIES

Digital Relative Humidity module with Temperature output

MODULE PERFORMANCE

RELATIVE HUMIDITY

- HTU3833 Products**

(@T = 25°C, VDD=3VDC)

Characteristics		Symbol	Min	Typ	Max	Unit
Resolution	12 bits			0.04		%RH
	8 bits			0.7		%RH
Humidity Operating Range		RH	0		100	%RH
Relative Humidity Accuracy @25°C (20%RH to 80%RH)	typ			±2		%RH
	max			See RH error budget graph		%RH
Replacement		fully interchangeable				
Temperature coefficient (from 0°C to 80°C)		T _{cc}			-0.15	%RH/°C
Humidity Hysteresis				±1		%RH
Measuring Time ⁽¹⁾	12 bits			14	16	ms
	11 bits			7	8	ms
	10 bits			4	5	ms
	8 bits			2	3	ms
PSRR					±10	LSB
Recovery time after 150 hours of condensation		t		10		s
Long term drift				0.5		%RH/yr
Response Time (at 63% of signal) from 33 to 75%RH ⁽²⁾		T _{RH}		5	10	s

⁽¹⁾ Typical values are recommended for calculating energy consumption while maximum values shall be applied for calculating waiting times in communication.

⁽²⁾ At 1m/s air flow

- HTU3835 Products**

(@T = 25°C, VDD=5VDC)

Characteristics		Symbol	Min	Typ	Max	Unit
Resolution	12 bits			0.04		%RH
	8 bits			0.7		%RH
Humidity Operating Range		RH	0		100	%RH
Relative Humidity Accuracy @25°C (20%RH to 80%RH)	typ			±2		%RH
	max			See RH error budget graph		%RH
Replacement		fully interchangeable				
Temperature coefficient (from 0°C to 80°C)		T _{cc}			-0.15	%RH/°C
Humidity Hysteresis				±1		%RH
Measuring Time ⁽¹⁾	12 bits			14	16	ms
	11 bits			7	8	ms
	10 bits			4	5	ms
	8 bits			2	3	ms
Recovery time after 150 hours of condensation		t		10		s
Long term drift				0.5		%RH/yr
Response Time (at 63% of signal) from 33 to 75%RH ⁽²⁾		T _{RH}		5	10	s

HTU(F)3800 SERIES

Digital Relative Humidity module with Temperature output

- (1) Typical values are recommended for calculating energy consumption while maximum values shall be applied for calculating waiting times in communication.
- (2) At 1m/s air flow

RELATIVE HUMIDITY ERROR BUDGET CONDITIONS AT 25°C

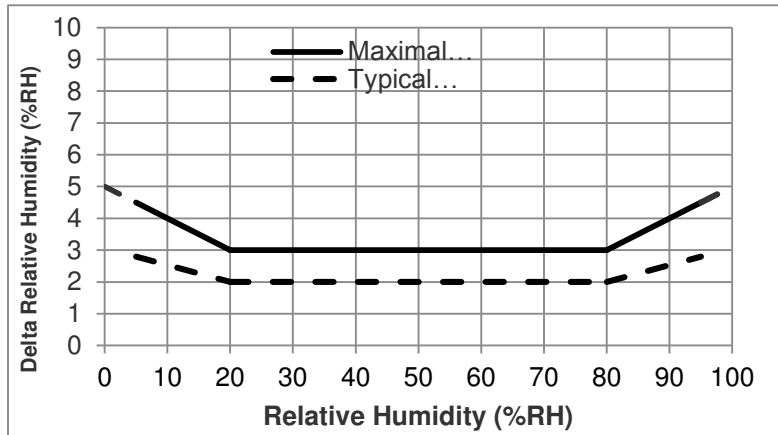

- HTU3800 Series modules are specified for optimum accuracy measurements within 5 to 95%RH.
- Operation out of this range (< 5% or > 95% RH, including condensation) is however possible

TEMPERATURE COEFFICIENT COMPENSATION EQUATION

Using the following temperature coefficient compensation equation will guarantee Relative Humidity accuracy given page 4, from 0°C to 80°C:

$$RH_{\text{compensated } T} = RH_{\text{actual } T} + f(T)$$

$RH_{\text{actual } T}$

T_{actual}

$f(T)$

Ambient humidity in %RH, computed from HTU3800 module

Humidity cell temperature in °C, computed from HTU3800 module

RH correction (in %RH) is a linear function of the temperature T (°C) as described below :

$$f(T) = -0.15 * (25 - T)$$

HTU(F)3800 SERIES

Digital Relative Humidity module with Temperature output

TEMPERATURE

Characteristics		Symbol	Min	Typ	Max	Unit
Resolution	14 bit			0.01		°C
	12 bit			0.04		°C
Temperature Operating Range		T	-40		+110	°C
Temperature Accuracy @25°C	typ			±0.3		°C
	max			See temperature error budget graph		°C
Replacement			fully interchangeable			
Measuring time ⁽¹⁾	14 bit			44	50	ms
	13 bit			22	25	ms
	12 bit			11	13	ms
	11 bit			6	7	ms
PSRR					±25	LSB
Long term drift				0.04		°C/yr
Response Time (at 63% of signal) from 15°C to 45°C ⁽²⁾		T _T		10		s

⁽¹⁾ Typical values are recommended for calculating energy consumption while maximum values shall be applied for calculating waiting times in communication.

⁽²⁾ At 1m/s air flow

TEMPERATURE ERROR BUDGET

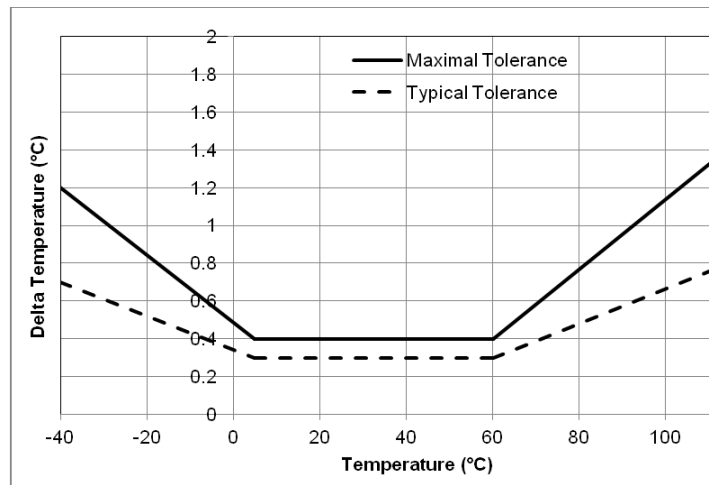

- **Storage Conditions and Handling Instructions**

It is recommended to store HTU3800 Series module in its original packaging at following conditions: Temperature shall be in the range of -40°C – 125°C.

HTU(F)3800 SERIES

Digital Relative Humidity module with Temperature output

- **ESD (ElectroStatic Discharge)**

ESD immunity is qualified according to:

- JEDEC JESD22-A114 method for connections & open window (Human Body Model at $\pm 8\text{kV}$ powered and unpowered for HTU3800).
- JEDEC JESD22-A115 method (Machine Model $\pm 200\text{V}$)

INTERFACE SPECIFICATION

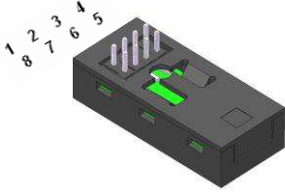
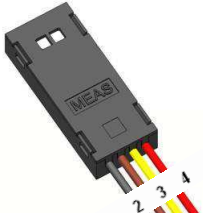
			HTU(F)383XPVBM	HTU(F)383XWxxGyy
N°	Function	Comment		
1/8	GND	Ground		
2/7	VCC	Voltage Supply		
3/6	SCK	Serial Clock Input		
4/5	DATA	Serial Data bidirectional		

- **Serial clock input (SCK)**

SCK is used to synchronize the communication between microcontroller and HTU3800 Series module. Since the interface consists of fully static logic there is no minimum SCK frequency.

- **Serial data (DATA)**

The DATA pin is used to transfer data in and out of the device. For sending a command to the HTU3800 Series sensor, DATA is valid on the rising edge of SCK and must remain stable while SCK is high. After the falling edge of SCK, the DATA value may be changed. For safe communication DATA shall be valid t_{SU} and t_{HD} before the rising and after the falling edge of SCK, respectively. For reading data from the HTU3800 Series module, DATA is valid t_{VD} after SCK has gone low and remains valid until the next falling edge of SCK.

ELECTRICAL CHARACTERISTICS

- **Input/output DC characteristics**

(VDD=3VDC for HTG3833 / VDD=5VDC for HTG3835, Temperature=25°C unless otherwise noted)

Characteristics	Symbol	Min	Typ	Max	Unit
Low level output voltage VDD=3V -4mA<IOL<0mA	VOL	0	-	0.4	V
High level output voltage	VOH	70%VDD	-	VDD	V
Low level input voltage	VIL	0	-	30%VDD	V
High level input voltage	VIH	70%VDD	-	VDD	V

- **Timing specifications of digital input/output pads for I²C fast mode**

Characteristics	Symbol	Min	Typ	Max	Unit
SCK frequency	f _{SCK}	0	-	0.4	MHz
SCK high time	t _{SCKLH}	0.6	-	-	μs
SCK low time	t _{SCKLL}	1.3	-	-	μs
DATA set-up time	t _{SU}	100	-	-	ns
DATA hold-time	t _{HD}	0	-	900	ns
DATA valid-time	t _{VD}	0	-	400	ns
SCK/DATA fall time	t _F	0	-	100	ns
SCK/DATA rise time	t _R	0	-	300	ns
Capacitive load on bus line	C _B	0	-	500	pF

- **Timing diagram for digital input/output pads**

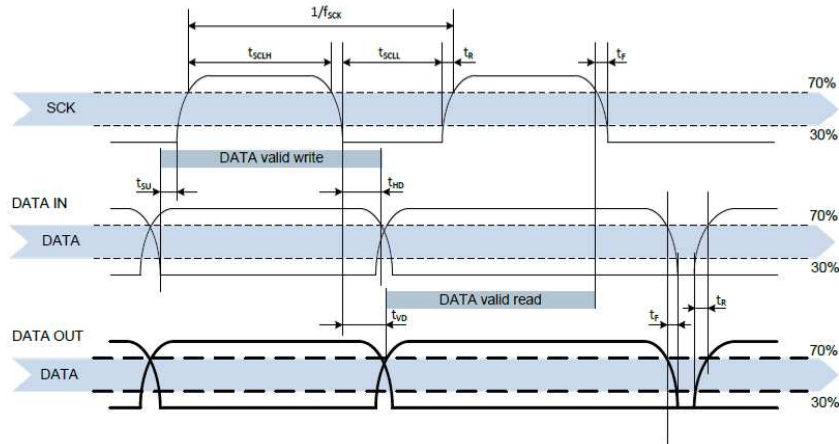

DATA directions are seen from the HTU3800 Series module. DATA line in bold is controlled by the module. DATA valid read time is triggered by falling edge of anterior toggle.

COMMUNICATION PROTOCOL WITH HTU3800 SERIES MODULE

- **Start-up module**

The HTU3833 module requires a voltage supply between 1.5V and 3.6V.

The HTU3835 module requires a voltage supply between 4.75V and 5.25V.

After power up, the device needs at most 15ms while SCK is high for reaching idle state (sleep mode), i.e to be ready accepting commands from the MCU. No command should be sent before that time. Soft reset is recommended at start, refer p.10.

- **Start sequence (S)**

To initiate transmission, a start bit has to be issued. It consists of a lowering of the DATA line while SCK is high followed by lowering SCK.

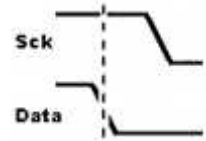

- **Stop sequence (P)**

To stop transmission, a stop bit has to be issued. It consists of a heightening of the DATA line while SCK is high preceded by a heightening of the SCK.

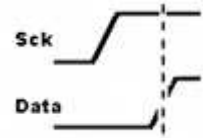

HTU3800 SERIES MODULE LIST OF COMMANDS AND REGISTER ADDRESSES

For sample source code, please request to humidity.application@te.com.

- **Sending a command**

After sending the start condition, the subsequent I²C header consist of a 7-bit I²C device address 0x40 and a DATA direction bit ('0' for Write access: 0x80). The HTU3800 Series module indicates the proper reception of a byte by pulling the DATA pin low (ACK bit) after the falling edge of the 8th SCK clock. After the issue of a measurement command (0xE3 for temperature, 0xE5 for relative humidity), the MCU must wait for the measurement to complete. The basic commands are given in the *Command table* below:

Command	Code	Comment
Trigger Temperature Measurement	0xE3	Hold master
Trigger Humidity Measurement	0xE5	Hold master
Trigger Temperature Measurement	0xF3	No Hold master
Trigger Humidity Measurement	0xF5	No Hold master
Write user register	0xE6	
Read user register	0xE7	
Soft Reset	0xFE	

- **Hold/No Hold master modes**

There are two different operation modes to communicate with the HTU3800 Series module: Hold Master mode and No Hold Master mode.

In the first case, the SCK line is blocked (controlled by HTU3800 Series module) during measurement process while in the second case the SCK line remain open for other communication while the module is processing the measurement.

No Hold Master mode allows for processing other I²C communication tasks on a bus while the HTU3800 Series module is measuring. A communication sequence of the two modes is available below.

In the Hold Master mode, the HTU3800 Series module pulls down the SCK line while measuring to force the master into a wait state. By releasing the SCK line, the HTU3800 Series module indicates that internal processing is completed and that transmission may be continued.

HTU(F)3800 SERIES

Digital Relative Humidity module with Temperature output

In the No Hold Master mode, the MCU has to poll for the termination of the internal processing of the HTU3800 Series module. This is done by sending a start condition followed by the I²C header ('1' for read access: 0x81) as shown below. If the internal processing is finished, the HTU3800 Series module acknowledges the poll of the MCU and data can be read by the MCU. If the measurement processing is not finished, the HTU3800 Series module answers no ACK bit and start condition must be issued once more.

For both modes, since the maximum resolution of the measurement is 14 bits, the two last least significant bits (LSBs, bits 43 and 44) are used for transmitting status information. Bit 1 of the two LSBs indicates the measurement type ('0': temperature, '1': humidity). Bit 0 is currently not assigned.

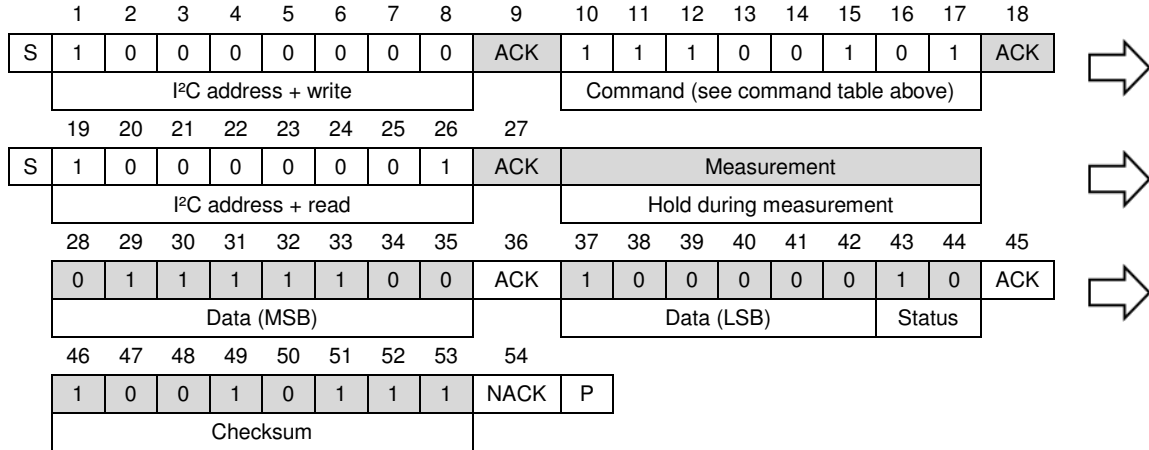

Hold Master communication sequence

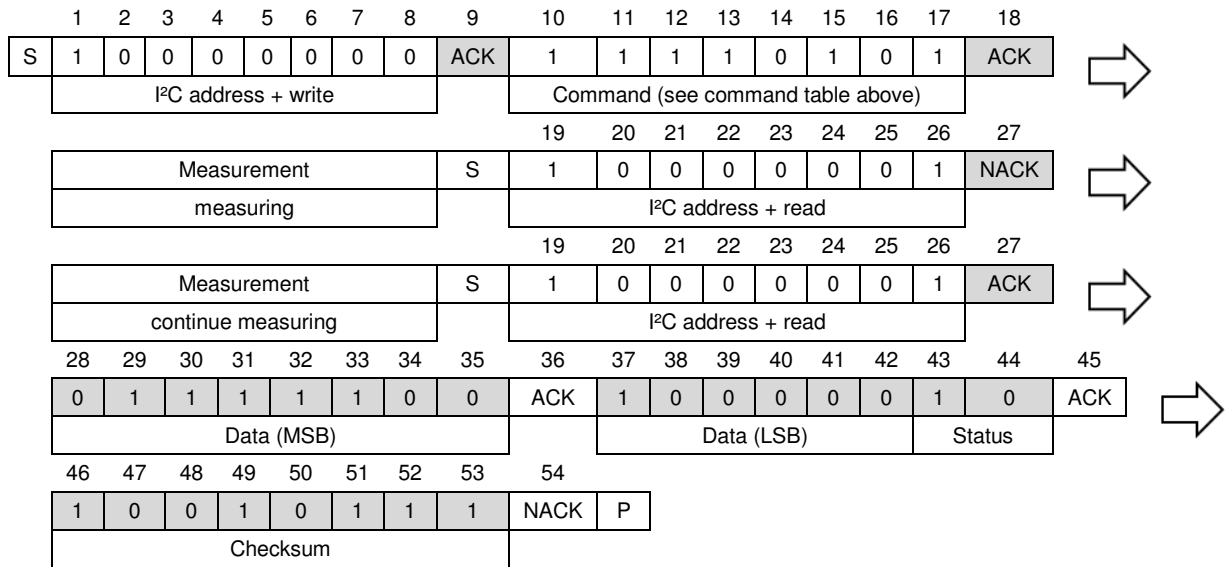

No Hold Master communication sequence

Grey blocks are controlled by HTU3800 Series module.

For Hold Master sequence, bit 45 may be changed to NACK followed by a stop condition to omit checksum transmission.

HTU(F)3800 SERIES

Digital Relative Humidity module with Temperature output

For No Hold Master sequence, if measurement is not completed upon “read” command, module does not provide ACK on bit 27 (more of these iterations are possible). If bit 45 is changed to NACK followed by stop condition, checksum transmission is omitted.

In those examples, the HTU3800 Series module output is $S_{RH} = '0110'0011'0101'0000$ (0x6350). For the calculation of physical values status bits must be set to '0'. Refer to § “Conversion of signal outputs”.

The maximum duration for measurement depends on the type of measurement and resolution chosen. Maximum values shall be chosen for the communication planning of the MCU. Refer to the characteristics tables for HTU3833 products and for HTU3835 products regarding measuring time specifications.

I²C communication allows for repeated start conditions without closing prior sequence with stop condition.

- **Soft reset**

This command is used for rebooting the HTU3800 Series module switching the power off and on again. Upon reception of this command, the HTU3800 Series module system reinitializes and starts operation according to the default settings with the exception of the heater bit in the user register. The soft reset takes less than 15ms.

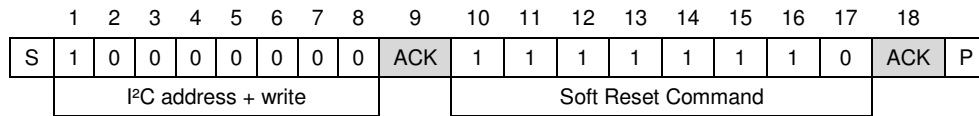

Grey blocks are controlled by HTU3800 Series module.

- **User register**

The content of user register is described in the table below. Reserved bits must not be changed and default values of respective reserved bits may change over time without prior notice. Therefore, for any writing to user register, default values of reserved bits must be read first.

The “End of Battery” alert/status is activated when the battery power falls below 2.25V.

The heater is intended to be used for functionality diagnosis: relative humidity drops upon rising temperature. For HTU3800 module, the heater consumes about 5.5mW and provides a temperature increase of about 0.5-1.5°C.

OTP reload is a safety feature and load the entire OTP settings to the register, with the exception of the heater bit, before every measurement. This feature is disabled per default and it is not recommended for use. Please use soft reset instead as it contains OTP reload.

Bit	#Bits	Description/Coding	Default																				
7,0	2	Measurement resolution <table border="1" style="margin-left: 20px;"> <thead> <tr> <th>Bit 7</th> <th>Bit 0</th> <th>RH</th> <th>Temp</th> </tr> </thead> <tbody> <tr> <td>0</td> <td>0</td> <td>12 bits</td> <td>14 bits</td> </tr> <tr> <td>0</td> <td>1</td> <td>8 bits</td> <td>12 bits</td> </tr> <tr> <td>1</td> <td>0</td> <td>10 bits</td> <td>13 bits</td> </tr> <tr> <td>1</td> <td>1</td> <td>11 bits</td> <td>11 bits</td> </tr> </tbody> </table>	Bit 7	Bit 0	RH	Temp	0	0	12 bits	14 bits	0	1	8 bits	12 bits	1	0	10 bits	13 bits	1	1	11 bits	11 bits	'00'
Bit 7	Bit 0	RH	Temp																				
0	0	12 bits	14 bits																				
0	1	8 bits	12 bits																				
1	0	10 bits	13 bits																				
1	1	11 bits	11 bits																				
6	1	Status: End of Battery ⁽¹⁾ '0': VDD>2.25V '1': VDD<2.25V	'0'																				
3, 4, 5	3	Reserved	'0'																				
2	1	Enable on-chip heater	'0'																				
1	1	Disable OTP reload	'1'																				

⁽¹⁾ This status bit is updated after each measurement

Cut-off value for “End of Battery” signal may vary by ±0.1V.

Reserved bits must not be changed.

OTP reload active loads default settings after each time a measurement command is issued.

- **I²C communication reading and writing the user register example**

In this example, the resolution is set to 8 bits / 12 bits (for RH/Temp) from default configuration.

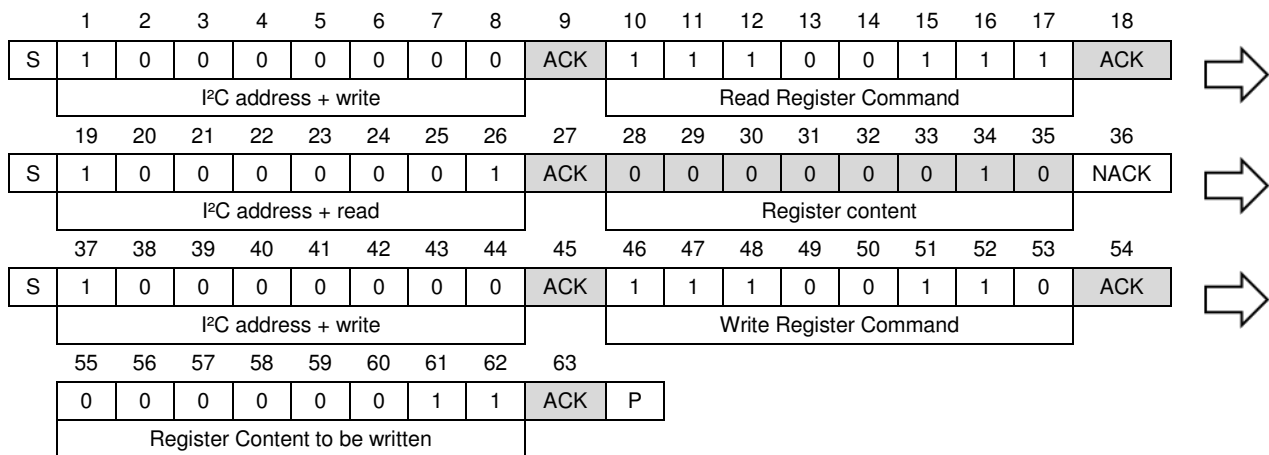

Grey blocks are controlled by HTU3800 Series module.

- **CRC Checksum**

HTU3800 Series module provides a CRC-8 checksum for error detection. The polynomial used is $X^8 + X^5 + X^4 + 1$.

Basic Considerations

CRC stands for Cyclic Redundancy Check. It is one of the most effective error detection schemes and requires a minimal amount of resources.

The types of errors that are detectable with CRC that is implemented in HTU3800 Series module are:

- Any odd number of errors anywhere within the data transmission
- All double-bit errors anywhere within the transmission
- Any cluster of errors that can be contained within an 8-bit window (1-8 bits incorrect)
- Most larger clusters of errors

A CRC is an error-detecting code commonly used in digital networks and storage devices to detect accidental changes to raw data.

Blocks of data entering these systems get a short check value attached, based on the remainder of a polynomial division of their contents; on retrieval the calculation is repeated, and corrective action can be taken against presumed data corruption if the check values do not match.

CRCs are so called because the check (data verification) value is a redundancy (it expands the message without adding information) and the algorithm is based on cyclic codes. CRCs are popular because they are simple to implement in binary hardware, easy to analyze mathematically, and particularly good at detecting common errors caused by noise in transmission channels. Because the check value has a fixed length, the function that generates it is occasionally used as a hash function.

CRC for HTU3800 Series modules using I²C Protocol

When HTU3800 Series modules are run by communicating with the standard I²C protocol, an 8-bit CRC can be used to detect transmission errors. The CRC covers all read data transmitted by the module. CRC properties for HTU21D(F) modules communicating with I²C protocol are listed in the table below.

CRC with I ² C protocol	
Generator polynomial	$X^8 + X^5 + X^4 + 1$
Initialization	0x00
Protected data	Read data
Final Operation	none

CRC calculation

To compute an n-bit binary CRC, line the bits representing the input in a row, and position the (n+1)-bit pattern representing the CRC's divisor (called a "polynomial") underneath the left-hand end of the row.

This is first padded with zeroes corresponding to the bit length n of the CRC.

If the input bit above the leftmost divisor bit is 0, do nothing. If the input bit above the leftmost divisor bit is 1, the divisor is XORed into the input (in other words, the input bit above each 1-bit in the divisor is toggled). The divisor is then shifted one bit to the right, and the process is repeated until the divisor reaches the right-hand end of the input row.

Since the left most divisor bit zeroed every input bit it touched, when this process ends the only bits in the input row that can be nonzero are the n bits at the right-hand end of the row. These n bits are the remainder of the division step, and will also be the value of the CRC function.

The validity of a received message can easily be verified by performing the above calculation again, this time with the check value added instead of zeroes. The remainder should equal zero if there are no detectable errors.

CRC examples

The input message 11011100 (0xDC) will have as result 01111001 (0x79).

The input message 01101000 00111010 (0x683A: 24.7°C) will have as result 01111100 (0x7C).

The input message 01001110 10000101 (0x4E85: 32.3%RH) will have as result 01101011 (0x6B).

CONVERSION OF SIGNAL OUTPUTS

Default resolution is set to 12-bit relative humidity and 14-bit temperature readings. Measured data are transferred in two byte packages, i.e. in frames of 8-bit length where the most significant bit (MSB) is transferred first (left aligned). Each byte is followed by an acknowledge bit. The two status bits, the last bits of LSB, must be set to '0' before calculating physical values.

To accommodate/adapt any process variation (nominal capacitance value of the humidity die), tolerances of the module above 100%RH and below 0%RH must be considered. As a consequence:

- 118%RH corresponds to 0xFF which is the maximum RH digital output that can be sent out from the ASIC. RH output can reach 118%RH and above this value, there will have a clamp of the RH output to this value.
- -6%RH corresponds to 0x00 which is the minimum RH digital output that can be sent out from the ASIC. RH output can reach -6%RH and below this value, there will have a clamp of the RH output to this value.

- **Relative Humidity conversion**

With the relative humidity signal output S_{RH} , the relative humidity is obtained by the following formula (result in %RH), no matter which resolution is chosen:

$$RH = -6 + 125 \times \frac{S_{RH}}{2^{16}}$$

In the example above, the transferred 16-bit relative humidity data is 0x7C80: 31872. The relative humidity results to be 54.8%RH.

- **Temperature conversion**

The temperature T is calculated by inserting temperature signal output S_{Temp} into the following formula (result in °C), no matter which resolution is chosen:

$$Temp = -46.85 + 175.72 \times \frac{S_{Temp}}{2^{16}}$$

HTU(F)3800 SERIES

Digital Relative Humidity module with Temperature output

APPLICATION: DEW POINT TEMPERATURE MEASUREMENT

The **dew point** is the temperature at which the water vapor in the air becomes saturated and condensation begins.

The dew point is associated with relative humidity. A high relative humidity indicates that the dew point is closer to the current air temperature. Relative humidity of 100% indicates that the dew point is equal to the current temperature (and the air is maximally saturated with water). When the dew point stays constant and temperature increases, relative humidity will decrease.

Dew point temperature of the air is calculated using Ambient Relative Humidity and Temperature measurements from HTU3800 Series module with following formulas given below:

Partial Pressure ($PP_{T_{amb}}$) formula from Ambient Temperature:

$$PP_{T_{amb}} = 10^{\left[A - \frac{B}{(T_{amb} + C)} \right]}$$

Dew point Temperature (T_d) formula from Partial Pressure ($PP_{T_{amb}}$):

$$T_d = - \left[\frac{B}{\log_{10} \left(RH_{amb} \times \frac{PP_{T_{amb}}}{100} \right) - A} + C \right]$$

$PP_{T_{amb}}$	Partial Pressure in mmHg at ambient temperature (T_{amb})
RH_{amb}	Ambient humidity in %RH, computed from HTU3800 Series module
T_{amb}	Humidity cell temperature in °C, computed from HTU3800 Series module
T_d	Calculated Dew Point in °C
A, B, C	Constants: A=8.1332; B=1762.39; C=235.66

CONNECTING AND MECHANICAL CHARACTERISTICS

CONNECTING CHARACTERISTICS

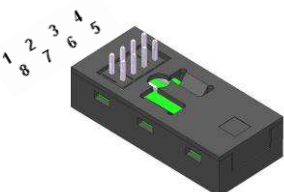
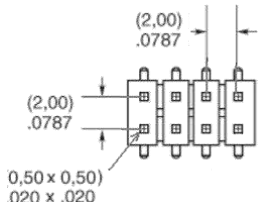
Connector Type*	Symbol	Overview	Connector Pitch	Mating Connector
Medium Male Connector ^{(1) (2)} (1.91 mm – 0.075 in long)	PVBM			Direct Soldering (through hole)

* For alternate connector type, please contact factory.

⁽¹⁾ For board-to-board mounting, we suggest wave soldering.

⁽²⁾ Pins are connected by twos.

HTU(F)3800 SERIES

Digital Relative Humidity module with Temperature output

Pin Out Assignment

N°	Function
1/8	Ground
2/7	SCK - Serial Clock Input
3/6	DATA – Serial Data
4/5	Vdd – Voltage Supply

WIRING CHARACTERISTICS

Symbol	Overview	Mating Connector*
WxxGyy		N/A

* On request, please contact factory.

Pin Out Assignment (with wires)

N°	Colour	Function
1	Black	Ground
2	Brown	SCK - Serial Clock Input
3	Yellow	DATA – Serial Data bidirectional
4	Red	Vcc – Voltage Supply

WIRING RECOMMENDATION

The I2C bus optimal functioning depends on the load of the I2C bus, wiring length and frequency. That is the reason why MEAS recommends to avoid long wiring cable when high frequency (as an example, maximum length of 200mm is recommended for 400 kHz according to HTU21 “Timing specifications of digital input/output pads for I²C fast mode” from this document).

For more information and other configuration, please refer to the I2C bus specification.

RESISTANCE TO PHYSICAL AND CHEMICAL STRESSES

HTU3800 series modules have been tested according to table below

Environment	Standard	Results
Salt atmosphere	JESD22-A107-A	Within specification
Temperature cycling	-20°C / +85°C, 168 hours	Within specification
Thermal shocks	-20°C / +85°C, 500 cycles	Within specification
High temperature / Humidity operating life	93%RH / +60°C, 168 hours	Within specification
Resistance to immersion into water	Ambient temp and 80°C	Within specification
Low temperature storage	-20°C, 500 hours	Within specification
High temperature storage	+85°C, 500 hours	Within specification
ESD immunity	JEDEC JESD22-A114 JEDEC JESD22-A115	Within specification

HTU(F)3800 SERIES

Digital Relative Humidity module with Temperature output

- Solder heat and solderability including lead free process
- Pb free wave soldering and reflow soldering processes (260°C) + DI water clean at 45°C

HTU3800 series modules contains circuits to protect its inputs and outputs against Electrostatic discharges (ESD) up to $\pm 15\text{kV}$, air discharge.

ENVIRONMENTAL AND RECYCLING

HTU3800 series modules are lead free components and are compatible with Lead Free soldering processes.

HTU3800 series modules are free from Cr (6+), Cd and Hg.

PACKAGE OUTLINE

MECHANICAL CHARACTERISTICS: HTU3800 SERIES PACKAGE OUTLINE

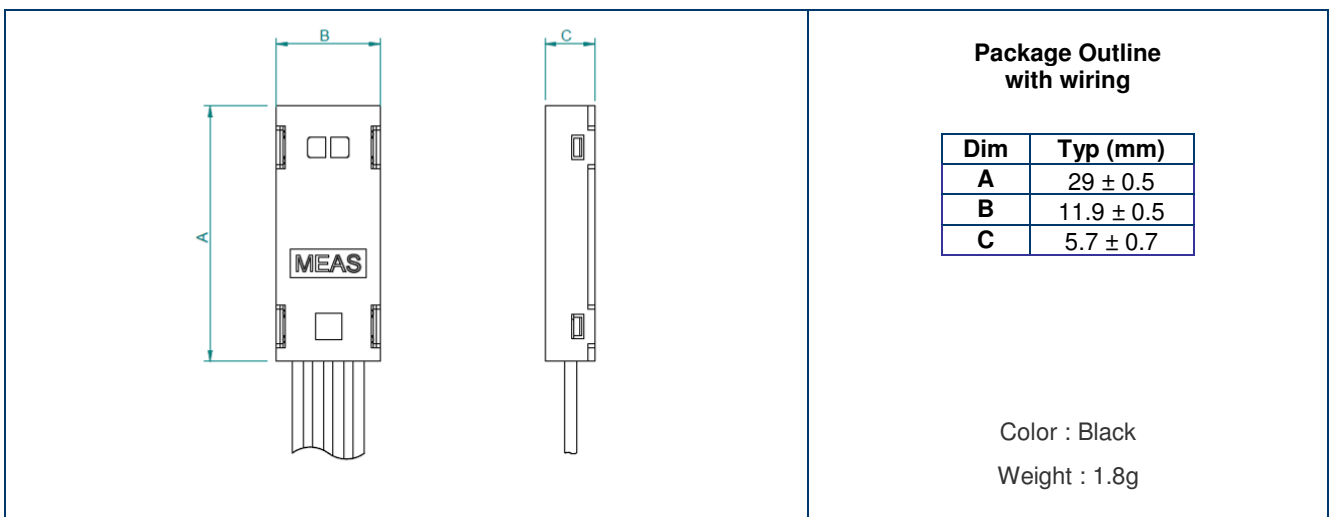
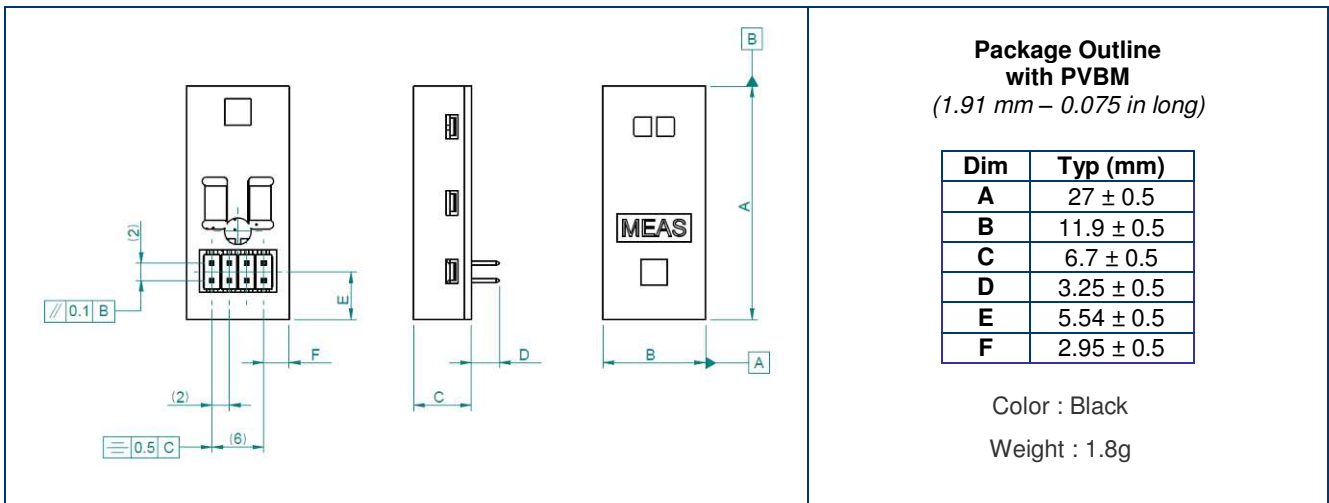

Double coated adhesive tape could be used on plastic housing area (ref: 3M – 5925F) to fix parts.

HTU(F)3800 SERIES

Digital Relative Humidity module with Temperature output

PACKAGING TYPE

HTU3800 modules are shipped in bulk in antistatic ESD bags.

ORDERING INFORMATION

Product	Order Reference	Status
HTUF3835W1300G26JST	HPP831E511	Serial part
HTUF3833WXGY	HPP831FXXX	Engineering part
HTUF3835PVBM	HPP831EXX	In design
HTUF3833PVBM	HPP831FXXX	In design
HTUF3835CH	HPP831EXXX	In design

For detailed information, please request to humidity.application@te.com

Samples are available through MEASUREMENT SPECIALTIES web site:

<http://www.meas-spec.com/humidity-sensors.aspx>

Revision	Comments	Who	Date
0	Document creation	D. LE GALL-ZIRILLI M.ROBERT	December 13
1	Ordering information update	M.ROBERT	September 14



Box 64, 123 22 FARSTA, Sweden
☎ +46 (0)8 683 33 00 ✉ automatik@wahlstrom.se
Visit us at www.swautomatik.se

TE.com/sensorsolutions

Measurement Specialties, Inc., a TE Connectivity company.

Measurement Specialties, TE Connectivity, TE Connectivity (logo) and EVERY CONNECTION COUNTS are trademarks. All other logos, products and/or company names referred to herein might be trademarks of their respective owners.

The information given herein, including drawings, illustrations and schematics which are intended for illustration purposes only, is believed to be reliable. However, TE Connectivity makes no warranties as to its accuracy or completeness and disclaims any liability in connection with its use. TE Connectivity's obligations shall only be as set forth in TE Connectivity's Standard Terms and Conditions of Sale for this product and in no case will TE Connectivity be liable for any incidental, indirect or consequential damages arising out of the sale, resale, use or misuse of the product. Users of TE Connectivity products should make their own evaluation to determine the suitability of each such product for the specific application.

© 2015 TE Connectivity Ltd. family of companies All Rights Reserved.